

LEFT SIDE VIEW (SHOWING RAFTERS & STRAPPING)

THIS FILE DOES NOT INCLUDE THE TYPICAL SMP PLAN SET, CARDSTOCK PATTERNS, OR CONSTRUCTION GUIDES. THESE TEMPLATES MUST BE USED IN CONJUNCTION WITH THE FREE TUTORIAL, "HOW TO MAKE INEXPENSIVE METAL SIDING", AT: WWW.SCALEMODELPLANS.COM - LINKS & TIPS.

Software Licence Agreement:
This project is provided free of charge by www.ScaleModelPlans.com for Personal, non-profit group, and Model Railroader Club use. Please contact www.ScaleModelPlans.com for information concerning commercial application.

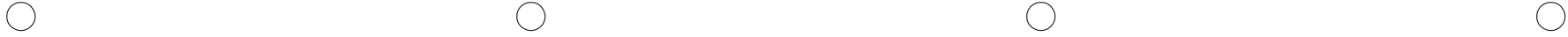

PLACEMENT OF VERTICAL POLES/COLUMNS

DR. BY: T. CARSON MAY 2011

EQUIPMENT SHED

SCALE: 0

(C) COPYRIGHT 2011 T. CARSON

WWW.SCALEMODELPLANS.COM

CADD SHEET 2 OF 7

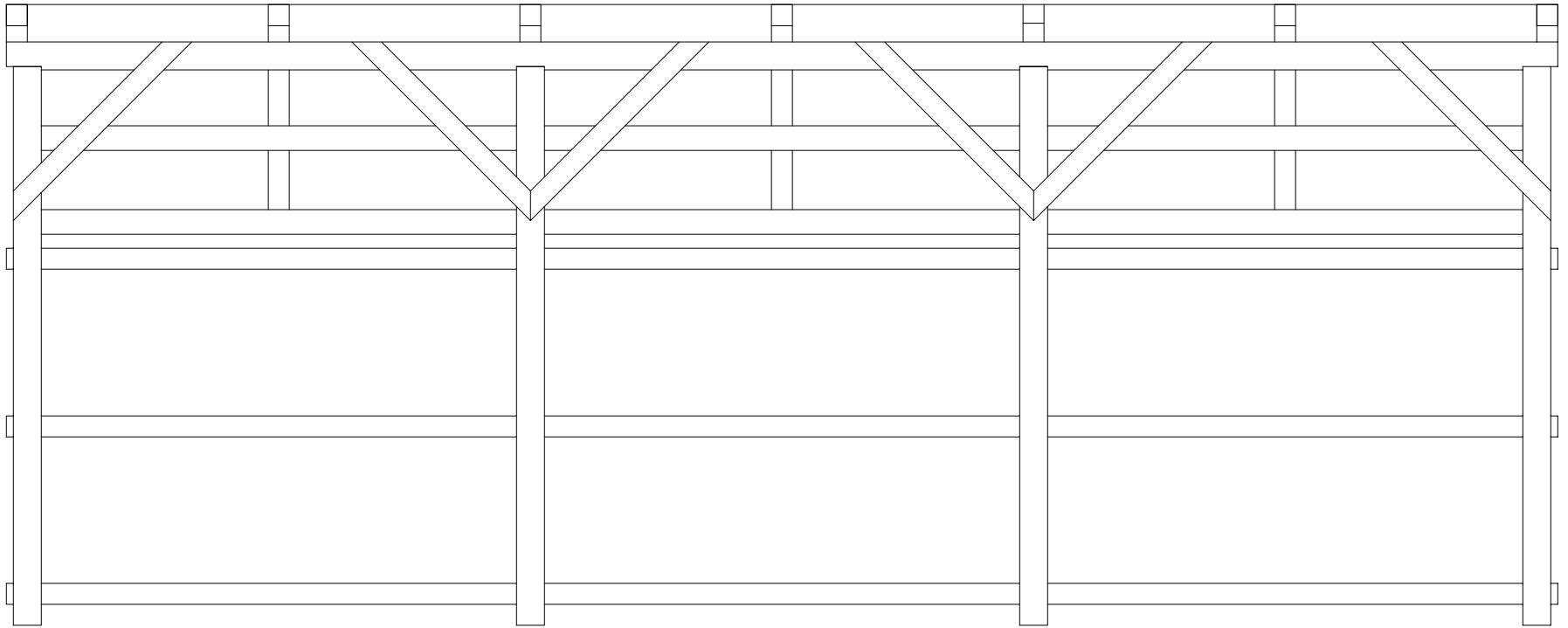

FRONT VIEW (SHOWING BEAMS & RAFTERS)

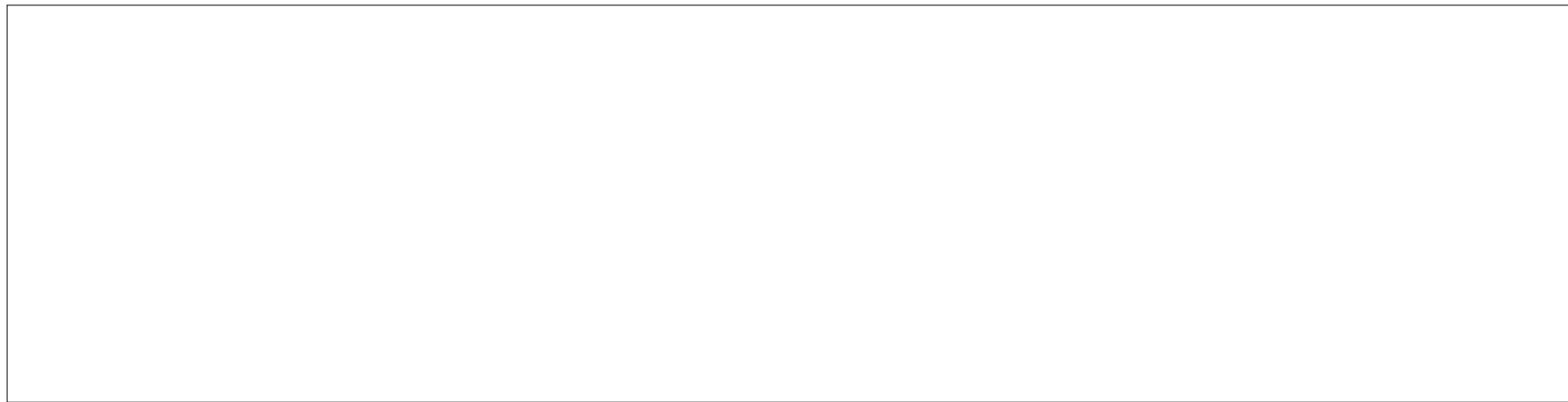

REAR WALL TEMPLATE

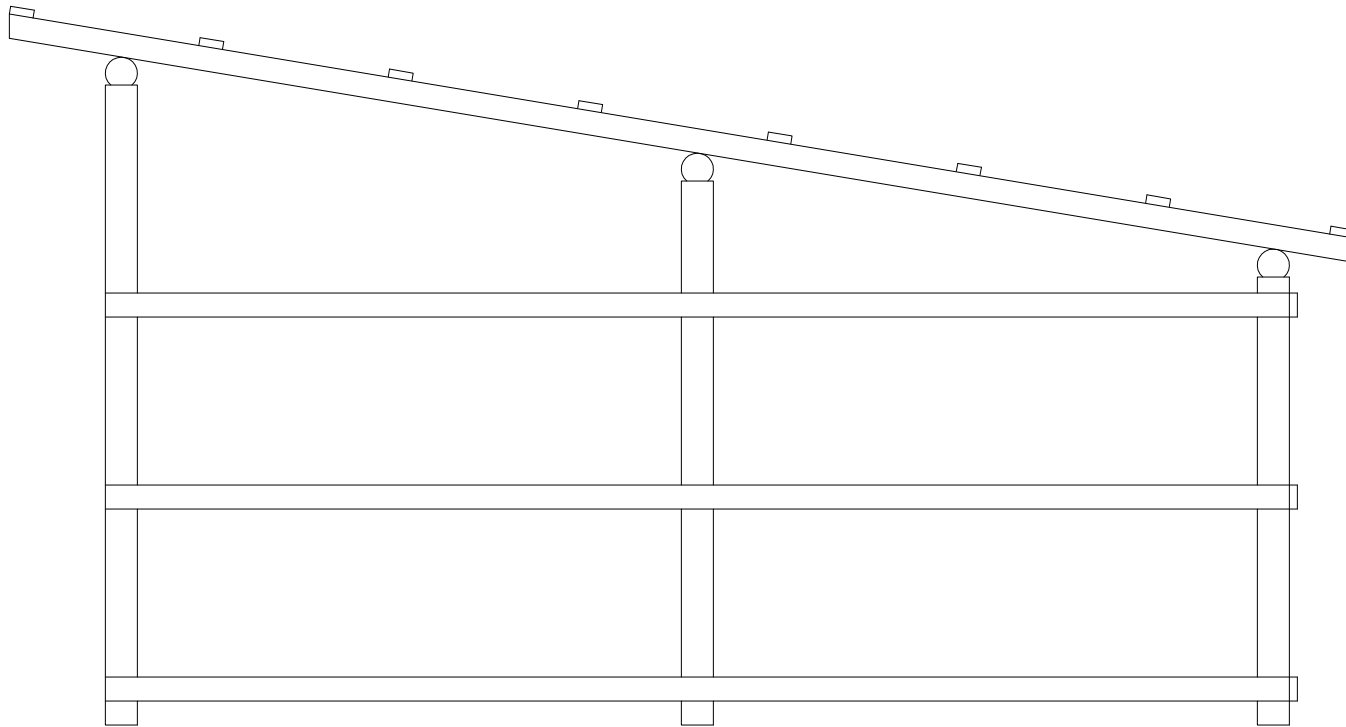

RIGHT SIDE VIEW (SHOWING RAFTERS & STRAPPING)

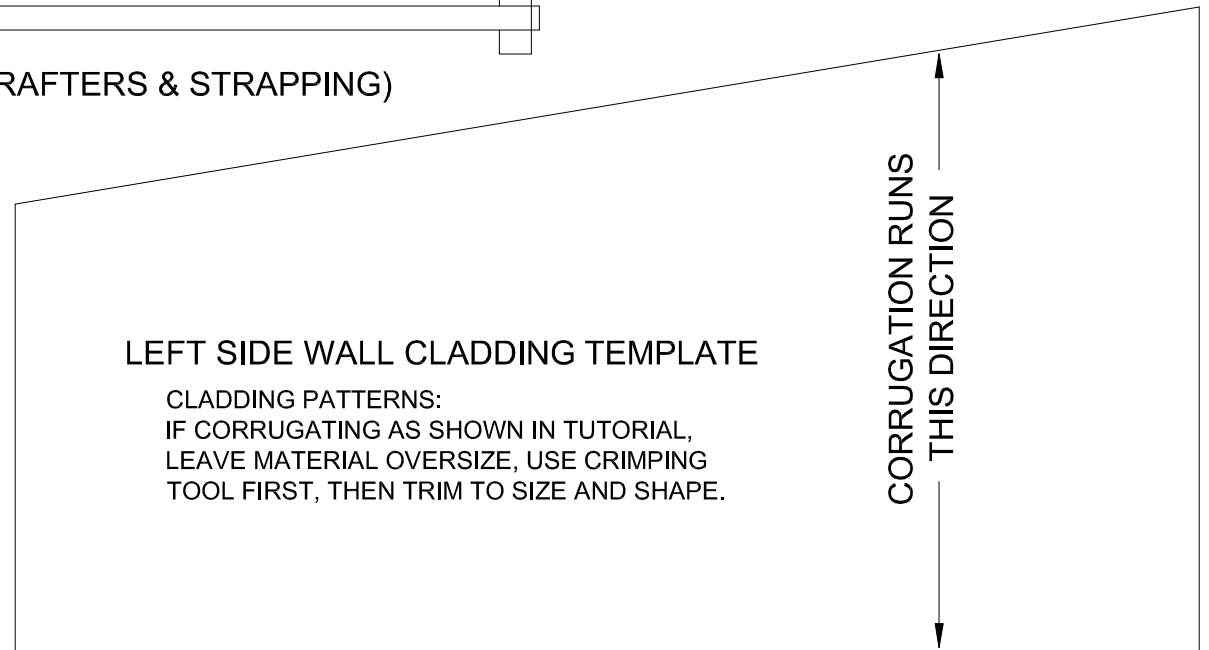

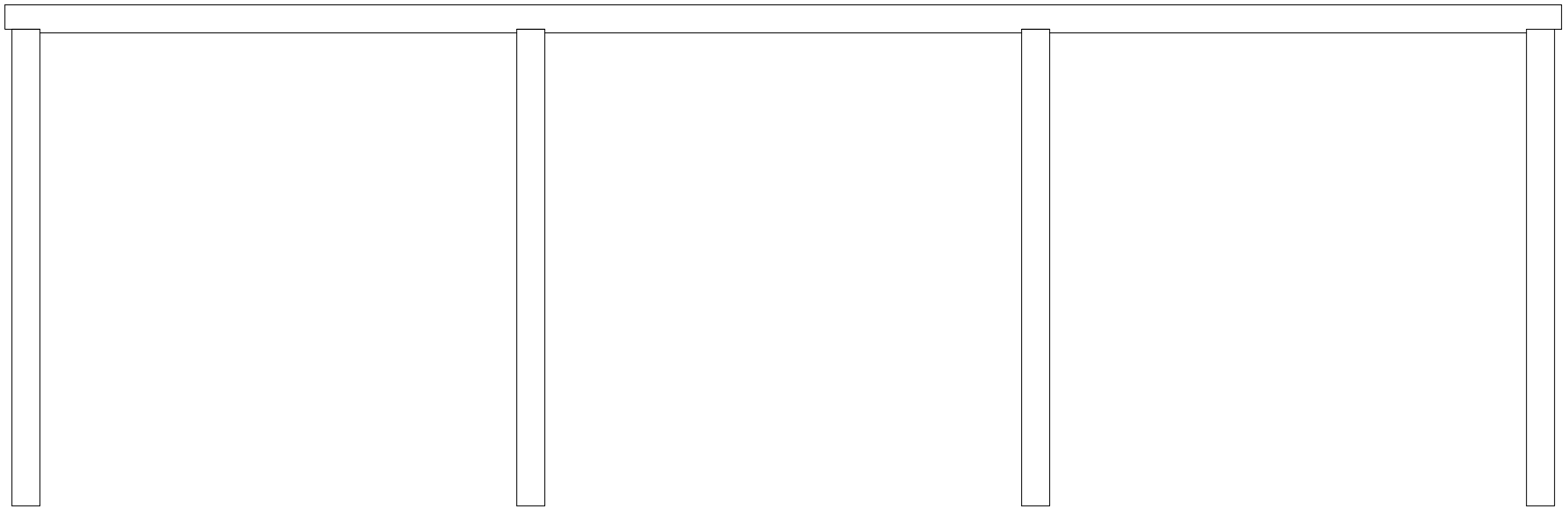
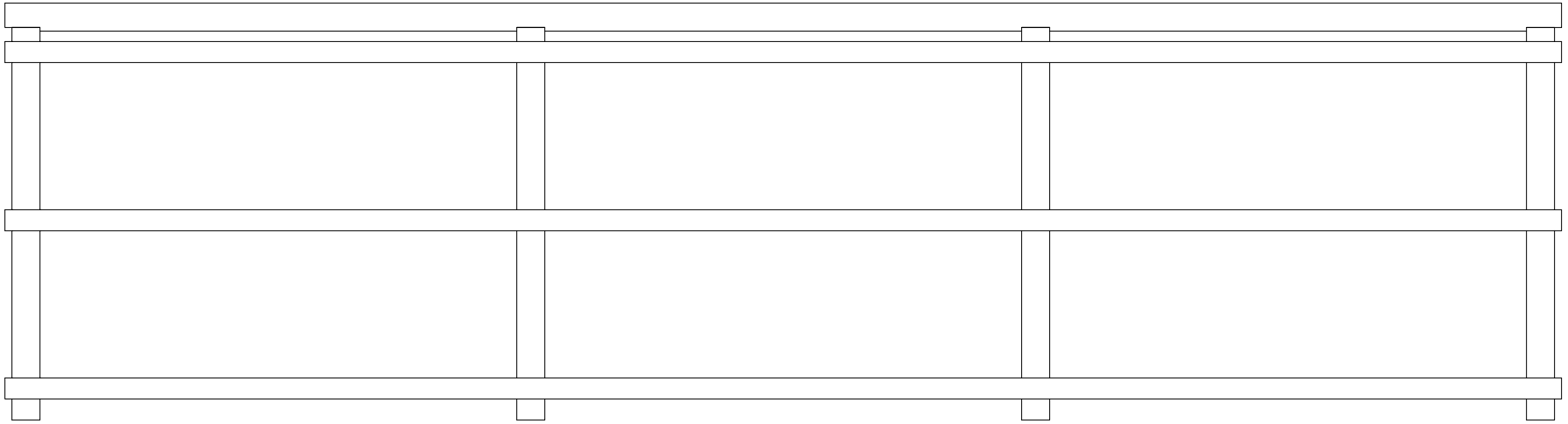

FRONT WALL: COLUMN & BEAM PLACEMENT

RIGHT SIDE WALL CLADDING TEMPLATE

CLADDING PATTERNS:
IF CORRUGATING AS SHOWN IN TUTORIAL,
LEAVE MATERIAL OVERSIZE, USE CRIMPING
TOOL FIRST, THEN TRIM TO SIZE AND SHAPE.



DIAGONAL BRACE TEMPLATE
(18 REQ'D)

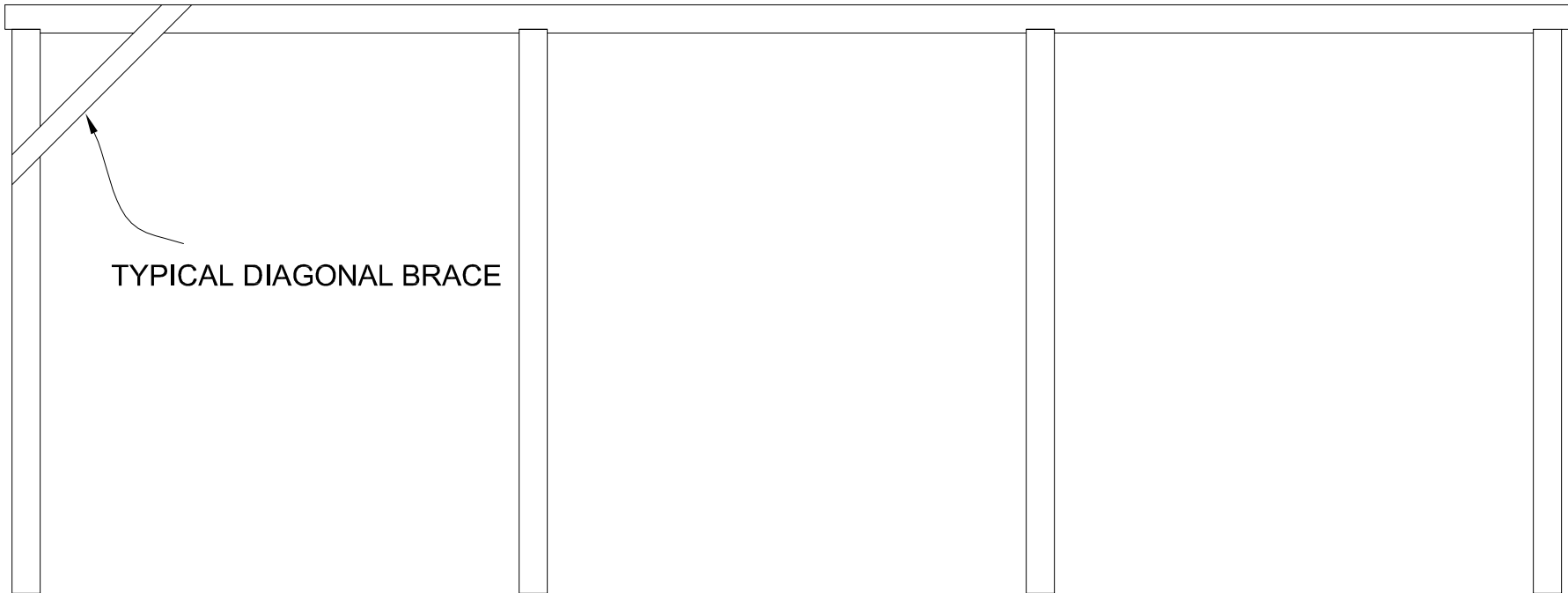

TYPICAL DIAGONAL BRACE

ROOF TEMPLATE (WITH OVERHANG)

CLADDING PATTERNS:
IF CORRUGATING AS SHOWN IN TUTORIAL,
LEAVE MATERIAL OVERSIZE, USE CRIMPING
TOOL FIRST, THEN TRIM TO SIZE AND SHAPE.



CORRUGATION RUNS THIS DIRECTION

